

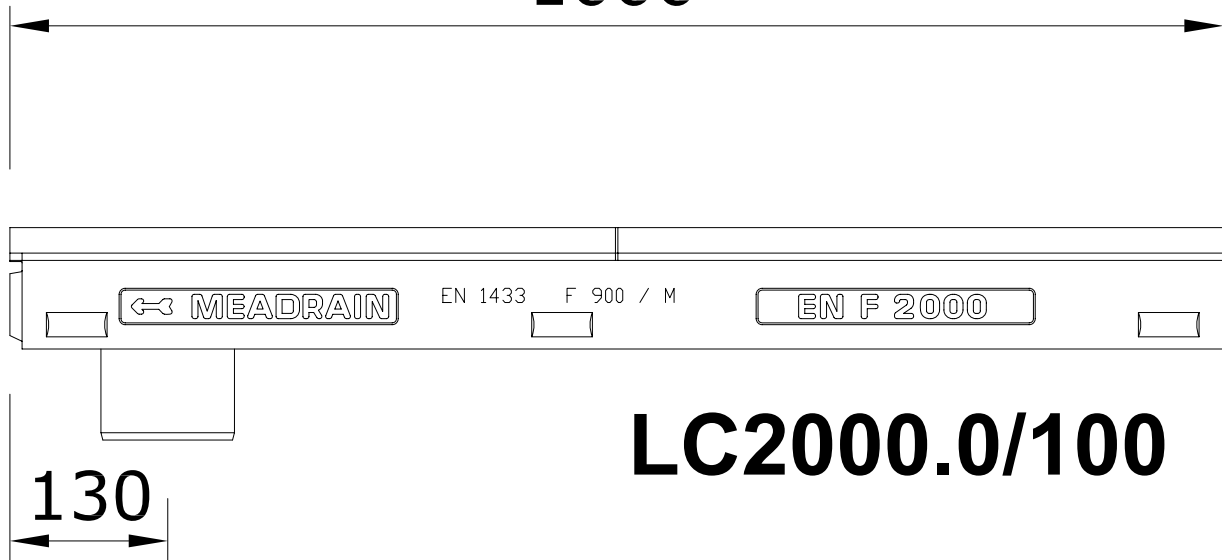

AS3996

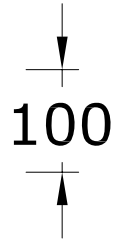

LC2000.0/100

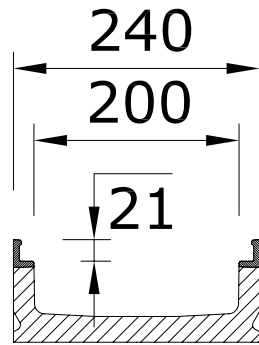
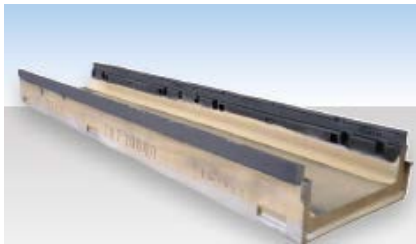

HYDRO CONSTRUCTION PRODUCTS
 AUSTRALIA & NEW ZEALAND
 TOLL FREE AU- 1300 GO
 HYDRO OR NZ- 0800 493 766
www.hydrocp.com.au or
www.hydrocp.co.nz

This document must not be copied without our written permission and the contents thereof must not be imported to a third party nor be used for any unauthorised purpose

HYDRO CONSTRUCTION PRODUCTS Copyright

PROJECT				REV.
DRAWING No. LC2000.0/100 Hydro Drain 200mm clear opening Polymer Concrete Channel (154611)				 THIRD ANGLE PROJECTION
DATE: 02/15	DRAWING CHECK:	DWG SIZE /SCALE A4 nts	QUOTE No.	
DRAWN: BG	CLIENT APPROVED:		PAGE 1/1	



AS3996

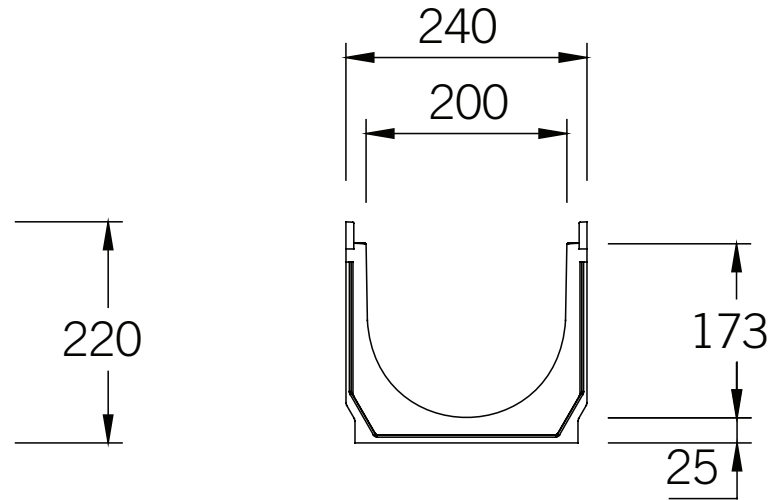
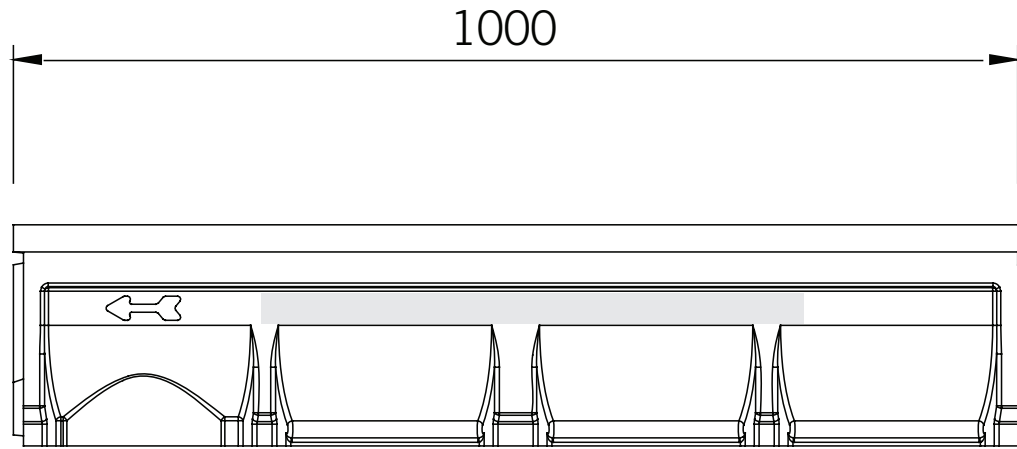

LC2000.0/220

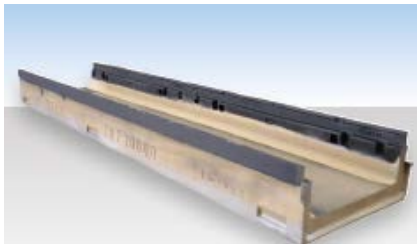

HYDRO CONSTRUCTION PRODUCTS
 AUSTRALIA & NEW ZEALAND
 TOLL FREE AU- 1300 GO
 HYDRO OR NZ- 0800 493 766
www.hydrocp.com.au or
www.hydrocp.co.nz

This document must not be copied without our written permission and the contents thereof must not be imported to a third party nor be used for any unauthorised purpose

HYDRO CONSTRUCTION PRODUCTS Copyright

PROJECT				REV.
DRAWING No.		LC2000.0/220 Hydro Drain 200mm clear opening		 THIRD ANGLE PROJECTION
		Polymer Concrete Channel (157285)		
DATE: 02/15	DRAWING CHECK:	DWG SIZE /SCALE A4	QUOTE No.	PAGE
DRAWN: BG	CLIENT APPROVED:	nts		1/1